

Description

- 0-4 metre sensing range
- 34 to 194 cross scanning beams
- Active height of 650 mm to 1800 mm
- Detector length 850 mm to 2100 mm
- Flexible cable connection
- Automatic sensitivity adjustment
- Slim line (10x28 mm), leading edge (37,5x13 mm) or water-resistant slim line (12x30 mm) detector housing
- Power, output and signal status indicators
- 12 – 36 V dc supply voltage
- 5 wire, solid state relay output
- Test input
- Time-out function via wire connection
- Static and dynamic applications



The SG 1 light curtain system consists of a self-contained transmitter detector, SGT and receiver detector, SGR, which are to be positioned opposite of each other. The detectors are housed in a sturdy aluminium profile available in a slim line design (10 x 28 mm), a leading edge design (37,5 x 13 mm) and a water-resistant slim line design (12 x 30 mm).

The SGR is supplied with a 12 – 36 V dc power supply with a 5 wire, solid state relay output, with a choice of light or dark function. The test input in the SGT may be used for either disabling or enabling the transmitting power temporarily for test purposes.

The detectors also include time-out function, which allows a pre-set number of non-adjacent channels to be automatically ignored if

permanently obstructed for 10 seconds or more. This function can be enabled or disabled via the connection wire.

The advanced automatic signal-tracking (AST) feature ensures that no onsite set up or adjustments are required. The signal level of each individual channel is adjusted automatically compensating for misalignment and contamination during operation. Transmitter and receiver detectors are optically synchronised. The system can be used both in static and dynamic installations.

Both the transmitter and receiver detectors are protected against reverse polarity of power supplies, control input and output signals. The output is also protected against short circuit and inductive loads.

Technical Data					
		46 mm channel spacing		92 mm channel spacing	
		SGT	SGR	SGT	SGR
Supply voltage		12 – 36 V dc			
Current consumption		Max. 100 mA	50 mA	Max. 100 mA	50 mA
Output rating Solid state		–	200 mA	–	200 mA
Short circuit protected		–	Yes	–	Yes
Reverse polarity protected		Yes			
Light source		Infrared (940 nm)	–	Infrared (940 nm)	–
Number of channels (diodes per detector)		16, 24, 32 or 40		8, 12, 16 or 20	
Number of cross scanning beams		74, 114, 154 or 194		34, 54, 74 or 94	
Active height		695, 1065, 1430 or 1800 mm		650, 1020, 1385 or 1755 mm	
Channel spacing		Between channel 1 and bottom of housing: 25 mm Between other channels: 46 mm		Between channel 1 and bottom of housing: 25 mm Between other channels: 92 mm	
Distance between beams at pinch point		23 mm		46 mm	
Response time		–	< 80 ms	–	< 40 ms
Power on indicator		Green LED			
Output indicator		–	Yellow LED	–	Yellow LED
System status indicator		–	Red LED	–	Red LED
Time-out function		Up to 4 non-adjacent channels, selectable		Up to 2 non-adjacent channels, selectable	
Housing dimensions (w x d)		Slim Line A		10 x 28 mm	
		Leading Edge B		37,5 x 13 mm	
		Slim Line C		12 x 30 mm	
Housing material		Profile		Aluminium (black anodised)	
		Lens cover		Polycarbonate	
Connection		3 m fixed flexible cable			
Cable, PVC Ø 4,1 mm		3 x 0,14 mm ²	5 x 0,14 mm ²	3 x 0,14 mm ²	5 x 0,14 mm ²

Environmental Data

Light immunity @ 5° incidence		> 100 000 lux
Temperature, operation		-20 to +65 °C
Temperature, storage		-40 to +80 °C
Sealing class	A/B housing	IP 54
	C housing	IP 67
Approvals		CE

Available Types

Slim Line A

	Housing Length	Active Height	Number of Channels	Number of Beams	Beam Spacing	Connection		3 m Flexible Cable	Range
						Output	Order reference		
Transmitter Detector	850 mm	650 mm	8	34	92 mm	-	-	SGT 1-085-008-B1-A-00-3F	4 m
		695 mm	16	74	46 mm			SGT 1-085-016-A1-A-00-3F	
	1250 mm	1020 mm	12	54	92 mm			SGT 1-125-012-B1-A-00-3F	
		1065 mm	24	114	46 mm			SGT 1-125-024-A1-A-00-3F	
	1600 mm	1385 mm	16	74	92 mm			SGT 1-160-016-B1-A-00-3F	
		1430 mm	32	154	46 mm			SGT 1-160-032-A1-A-00-3F	
	2000 mm	1755 mm	20	94	92 mm			SGT 1-200-020-B1-A-00-3F	
		1800 mm	40	194	46 mm			SGT 1-200-040-A1-A-00-3F	
	2100 mm	1755 mm	20	94	92 mm			SGT 1-210-020-B1-A-00-3F	
		1800 mm	40	194	46 mm			SGT 1-210-040-A1-A-00-3F	

	Housing Length	Active Height	Number of Channels	Number of Beams	Beam Spacing	Solid State Relay	Connection		Range
							Output	Order reference	
Receiver Detector	850 mm	650 mm	8	34	92 mm		NO	SGR 1-085-008-B1-A-04-3F	0-4 m
		695 mm	16	74	46 mm		NC	SGR 1-085-008-B1-A-05-3F	
	1250 mm	1020 mm	12	54	92 mm		NO	SGR 1-085-016-A1-A-04-3F	
		1065 mm	24	114	46 mm		NC	SGR 1-085-016-A1-A-05-3F	
	1600 mm	1385 mm	16	74	92 mm		NO	SGR 1-125-012-B1-A-04-3F	
		1430 mm	32	154	46 mm		NC	SGR 1-125-012-B1-A-05-3F	
	2000 mm	1755 mm	20	94	92 mm		NO	SGR 1-125-024-A1-A-04-3F	
		1800 mm	40	194	46 mm		NC	SGR 1-125-024-A1-A-05-3F	
	2100 mm	1755 mm	20	94	92 mm		NO	SGR 1-160-016-B1-A-04-3F	
		1800 mm	40	194	46 mm		NC	SGR 1-160-016-B1-A-05-3F	
	2000 mm	1755 mm	20	94	92 mm		NO	SGR 1-160-032-A1-A-04-3F	
							NC	SGR 1-160-032-A1-A-05-3F	
		1800 mm	40	194	46 mm		NO	SGR 1-200-020-B1-A-04-3F	
							NC	SGR 1-200-020-B1-A-05-3F	
		1755 mm	20	94	92 mm		NO	SGR 1-200-040-A1-A-04-3F	
							NC	SGR 1-200-040-A1-A-05-3F	
	1800 mm	40	194	46 mm	NO		SGR 1-210-020-B1-A-04-3F		
					NC		SGR 1-210-020-B1-A-05-3F		

- Note:**
- The transmitter SGT and receiver SGR set must have the same number of channels and beam spacing
 - The transmitter SGT is available in a long range model to be used in conjunction with standard receiver SGR. Sensing range is increased by 50%. Add "H" after the series number of the SGT for long range model, e.g. SGT 1H-200-040-A1-A-00-3F

Available Types

Leading Edge B

	Housing Length	Active Height	Number of Channels	Number of Beams	Beam Spacing	Connection		3 m Flexible Cable	Range
							Output	Order reference	
Transmitter Detector	850 mm	650 mm	8	34	92 mm	-	-	SGT 1-085-008-B1-B-00-3F	3 m
		695 mm	16	74	46 mm			SGT 1-085-016-A1-B-00-3F	
	1250 mm	1020 mm	12	54	92 mm			SGT 1-125-012-B1-B-00-3F	
		1065 mm	24	114	46 mm			SGT 1-125-024-A1-B-00-3F	
	1600 mm	1385 mm	16	74	92 mm			SGT 1-160-016-B1-B-00-3F	
		1430 mm	32	154	46 mm			SGT 1-160-032-A1-B-00-3F	
	2000 mm	1755 mm	20	94	92 mm			SGT 1-200-020-B1-B-00-3F	
		1800 mm	40	194	46 mm			SGT 1-200-040-A1-B-00-3F	
	2100 mm	1755 mm	20	94	92 mm			SGT 1-210-020-B1-B-00-3F	
		1800 mm	40	194	46 mm			SGT 1-210-040-A1-B-00-3F	

	Housing Length	Active Height	Number of Channels	Number of Beams	Beam Spacing	Solid State Relay	Connection		Range
								Output	
Receiver Detector	850 mm	650 mm	8	34	92 mm	Solid State Relay	NO	SGR 1-085-008-B1-B-04-3F	0-3 m
		695 mm	16	74	46 mm		NC	SGR 1-085-008-B1-B-05-3F	
	1250 mm	1020 mm	12	54	92 mm		NO	SGR 1-085-016-A1-B-04-3F	
		1065 mm	24	114	46 mm		NC	SGR 1-085-016-A1-B-05-3F	
	1600 mm	1385 mm	16	74	92 mm		NO	SGR 1-125-012-B1-B-04-3F	
		1430 mm	32	154	46 mm		NC	SGR 1-125-012-B1-B-05-3F	
	2000 mm	1755 mm	20	94	92 mm		NO	SGR 1-125-024-A1-B-04-3F	
		1800 mm	40	194	46 mm		NC	SGR 1-125-024-A1-B-05-3F	
	2100 mm	1755 mm	20	94	92 mm		NO	SGR 1-160-016-B1-B-04-3F	
		1800 mm	40	194	46 mm		NC	SGR 1-160-016-B1-B-05-3F	
	2000 mm	1755 mm	20	94	92 mm		NO	SGR 1-160-032-A1-B-04-3F	
		1800 mm	40	194	46 mm		NC	SGR 1-160-032-A1-B-05-3F	
	2000 mm	1755 mm	20	94	92 mm		NO	SGR 1-200-020-B1-B-04-3F	
		1800 mm	40	194	46 mm		NC	SGR 1-200-020-B1-B-05-3F	
	2100 mm	1755 mm	20	94	92 mm		NO	SGR 1-200-040-A1-B-04-3F	
		1800 mm	40	194	46 mm		NC	SGR 1-200-040-A1-B-05-3F	
	2100 mm	1755 mm	20	94	92 mm		NO	SGR 1-210-020-B1-B-04-3F	
		1800 mm	40	194	46 mm		NC	SGR 1-210-020-B1-B-05-3F	
	2100 mm	1755 mm	20	94	92 mm		NO	SGR 1-210-040-A1-B-04-3F	
		1800 mm	40	194	46 mm		NC	SGR 1-210-040-A1-B-05-3F	

- Note: 1. The transmitter SGT and receiver SGR set must have the same number of channels and beam spacing
 2. The transmitter SGT is available in a long range model to be used in conjunction with standard receiver SGR. Sensing range is increased by 50%.
 Add "H" after the series number of the SGT for long range model, e.g. SGT 1H-200-040-A1-B-00-3F

Available Types

Slim Line C

Transmitter Detector	Housing Length	Active Height	Number of Channels	Number of Beams	Beam Spacing	Connection		3 m Flexible Cable	Range
							Output	Order reference	
	850 mm	650 mm	8	34	92 mm	-	-	SGT 1-085-008-B1-C-00-3F	4 m
		695 mm	16	74	46 mm			SGT 1-085-016-A1-C-00-3F	
	1250 mm	1020 mm	12	54	92 mm			SGT 1-125-012-B1-C-00-3F	
		1065 mm	24	114	46 mm			SGT 1-125-024-A1-C-00-3F	
	1600 mm	1385 mm	16	74	92 mm			SGT 1-160-016-B1-C-00-3F	
		1430 mm	32	154	46 mm			SGT 1-160-032-A1-C-00-3F	
	2000 mm	1755 mm	20	94	92 mm			SGT 1-200-020-B1-C-00-3F	
		1800 mm	40	194	46 mm			SGT 1-200-040-A1-C-00-3F	

Receiver Detector	Housing Length	Active Height	Number of Channels	Number of Beams	Beam Spacing	Solid State Relay	Connection		Range	
								Output		
	850 mm	650 mm	8	34	92 mm	Solid State Relay	NO	SGR 1-085-008-B1-C-04-3F	0-4 m	
		695 mm	16	74	46 mm		NC	SGR 1-085-008-B1-C-05-3F		
	1250 mm	1020 mm	12	54	92 mm		NO	SGR 1-085-016-A1-C-04-3F		
		1065 mm	24	114	46 mm		NC	SGR 1-085-016-A1-C-05-3F		
	1600 mm	1385 mm	16	74	92 mm		NO	SGR 1-125-012-B1-C-04-3F		
		1430 mm	32	154	46 mm		NC	SGR 1-125-012-B1-C-05-3F		
	2000 mm	1755 mm	20	94	92 mm		NO	SGR 1-125-024-A1-C-04-3F		
		1800 mm	40	194	46 mm		NC	SGR 1-125-024-A1-C-05-3F		
		850 mm	650 mm	8	34		92 mm	NO		SGR 1-160-016-B1-C-04-3F
			695 mm	16	74		46 mm	NC		SGR 1-160-016-B1-C-05-3F
		1250 mm	1020 mm	12	54		92 mm	NO		SGR 1-160-032-A1-C-04-3F
			1065 mm	24	114		46 mm	NC		SGR 1-160-032-A1-C-05-3F
		1600 mm	1385 mm	16	74		92 mm	NO		SGR 1-200-020-B1-C-04-3F
			1430 mm	32	154		46 mm	NC		SGR 1-200-020-B1-C-05-3F
		2000 mm	1755 mm	20	94		92 mm	NO		SGR 1-200-040-A1-C-04-3F
			1800 mm	40	194		46 mm	NC		SGR 1-200-040-A1-C-05-3F

- Note: 1. The transmitter SGT and receiver SGR set must have the same number of channels and beam spacing
 2. The transmitter SGT is available in a long range model to be used in conjunction with standard receiver SGR. Sensing range is increased by 50%.
 Add "H" after the series number of the SGT for long range model, e.g. SGT 1H-200-040-A1-C-00-3F

Wiring Diagrams

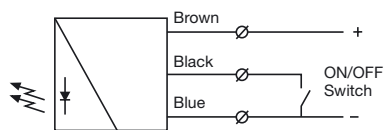

SGT 1

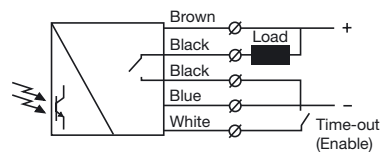

SGR 1 (Solid State Relay Output - load NPN)

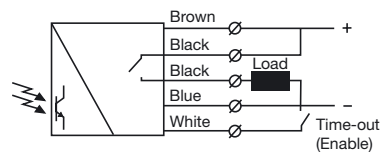

SGR 1 (Solid State Relay Output - load PNP)

Dimensions and Descriptions

Slim Line A

Details

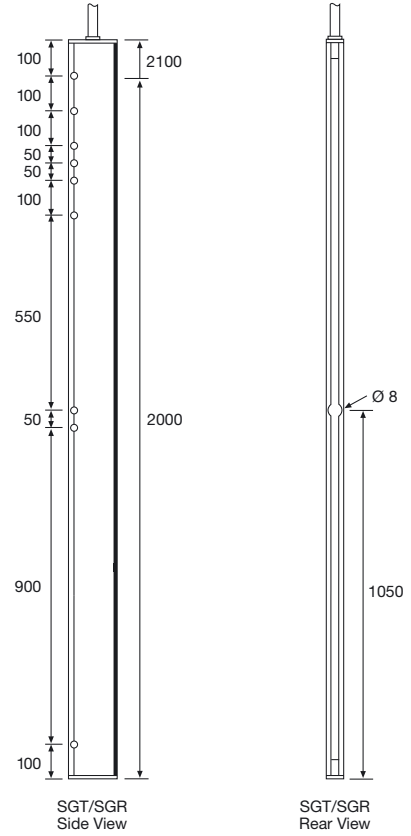
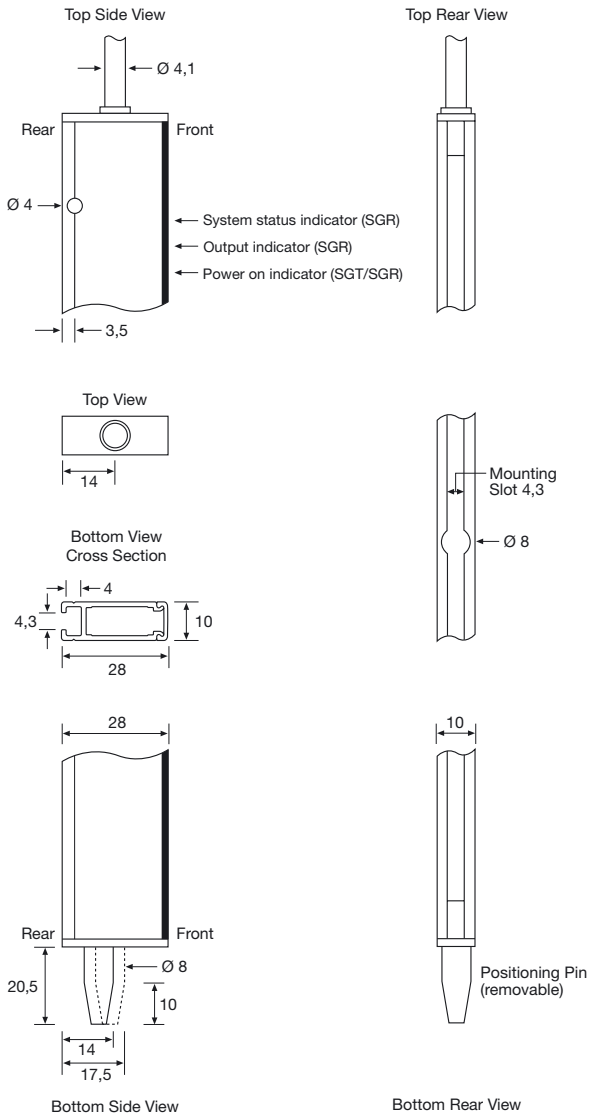

SGT/SGR 1-200/210

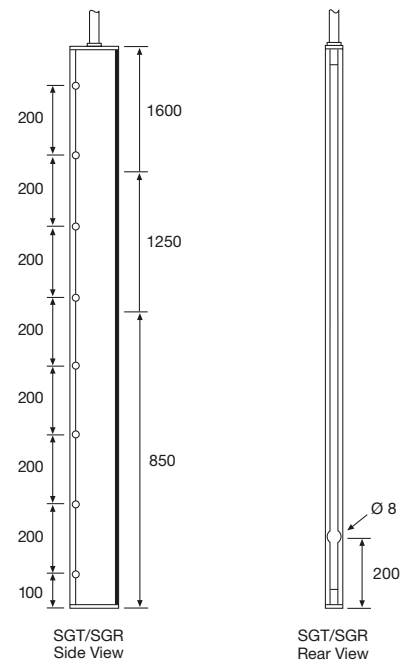

SGT/SGR 1-085/125/160

(Units in mm)

Dimensions and Descriptions

Leading Edge B

Details

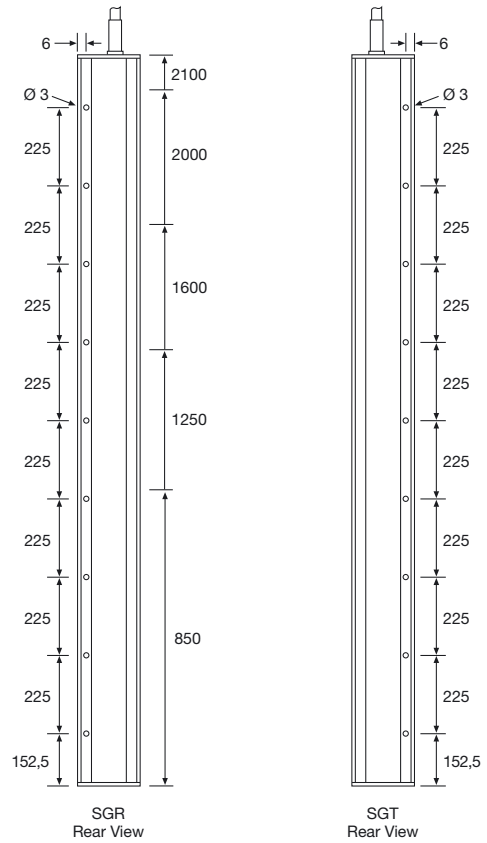
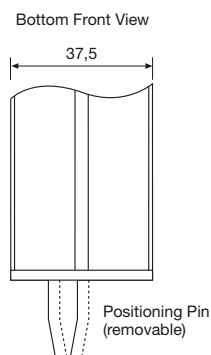
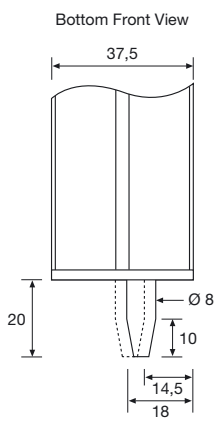
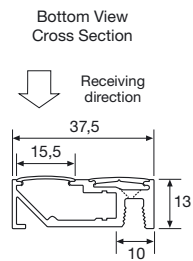
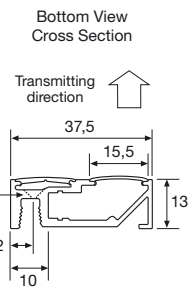
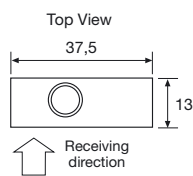
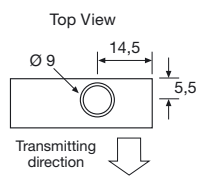
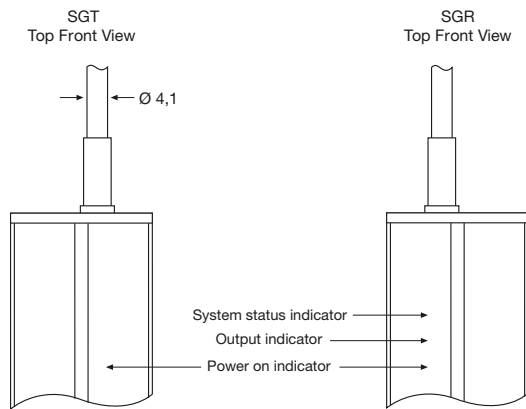

(Units in mm)

Dimensions and Descriptions

Water-Resistant Slim Line C

Details

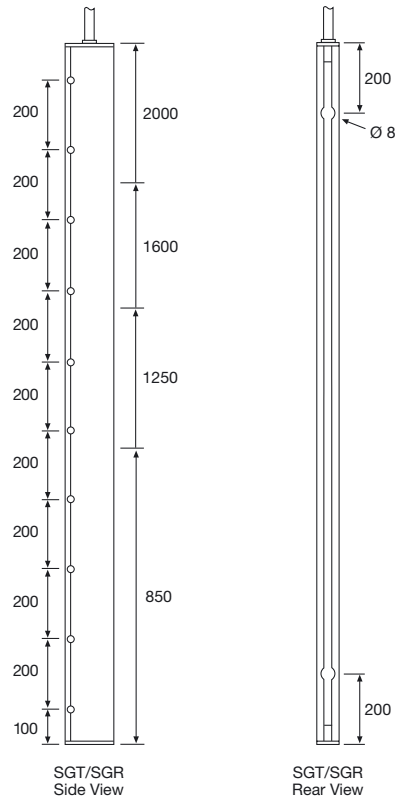
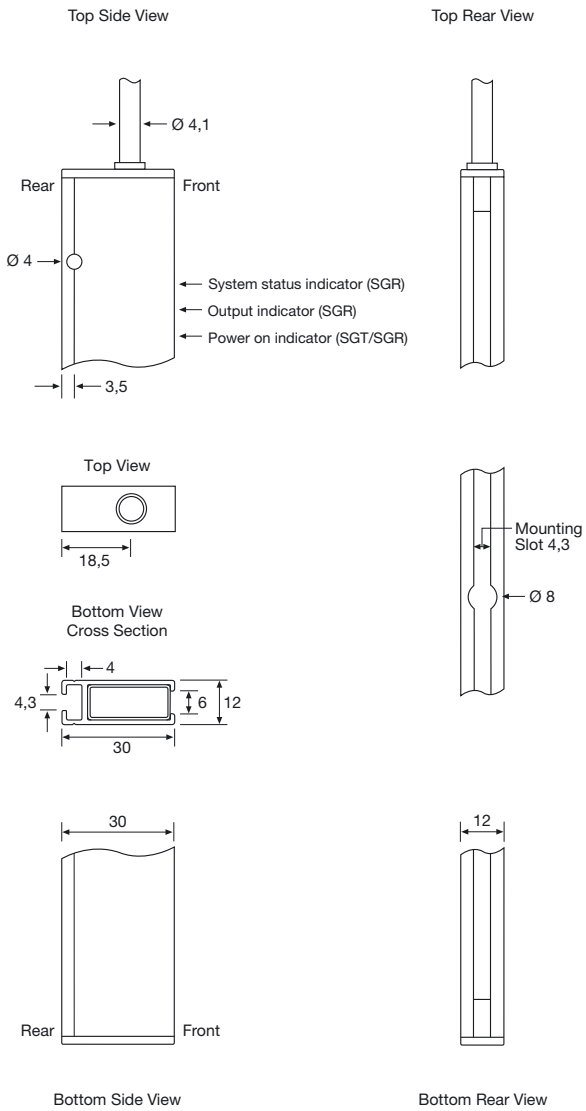

(Units in mm)

Beam Patterns

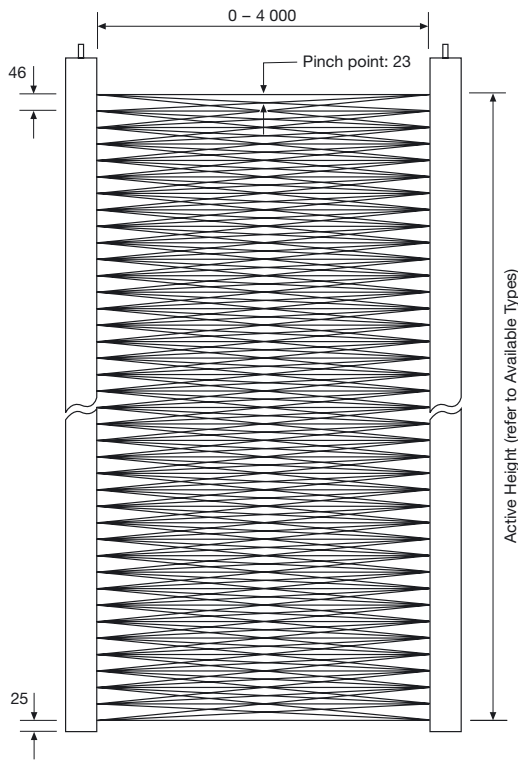

46 mm channel spacing

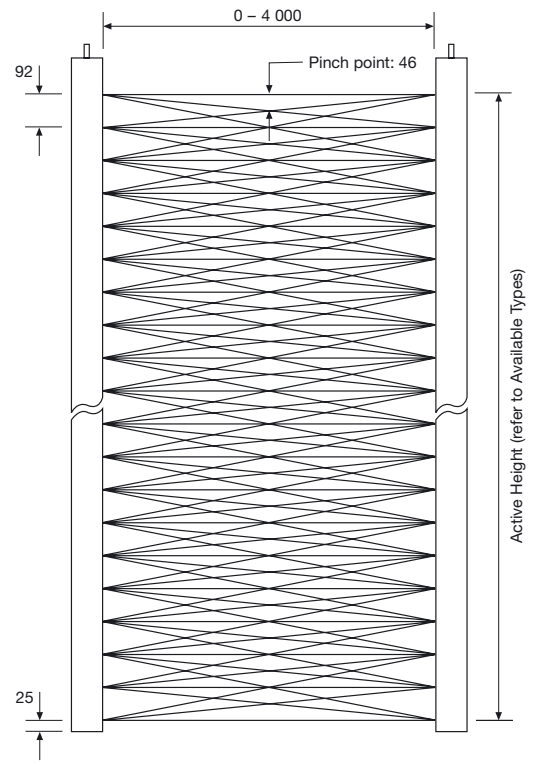

92 mm channel spacing

(Units in mm)

Sensing Characteristics

Parallel Displacement

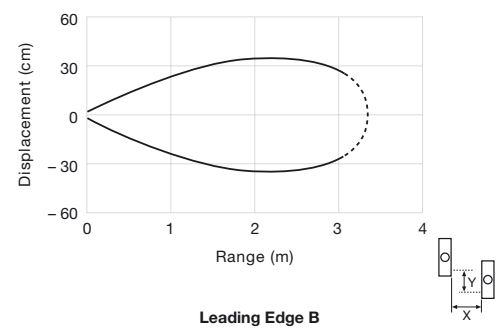
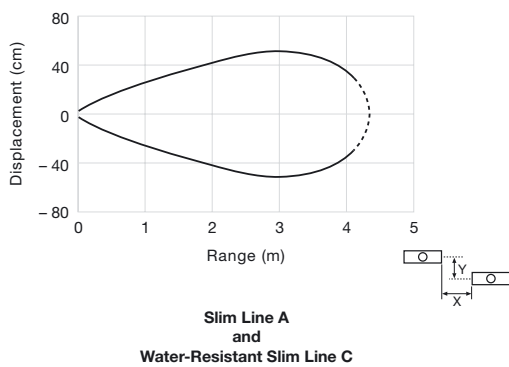

Telco reserves the right to change specifications without notice.