

Description

- 1-10 metre sensing range
- 16 to 56 parallel beams
- Active height of 695 mm to 2535 mm
- Detector length of 850 mm to 2800 mm
- Cable or plug connection
- Automatic sensitivity adjustment
- Slim line (10x28 mm), leading edge (37,5x13 mm) or water-resistant slim line (12x30 mm) detector housing
- Power, output and signal status indicators
- 12 – 36 V dc supply voltage
- Dynamic sequential blanking function
- 5 wire, solid state relay output
- Test input



The SG 14 light curtain system consists of a self-contained transmitter detector, SGT and receiver detector, SGR, which are to be positioned opposite of each other. The detectors are housed in a sturdy aluminium profile available in a slim line design (10 x 28 mm), a leading edge design (37,5 x 13 mm) and a water-resistant slim line design (12 x 30 mm).

The SGR is supplied with a 12 – 36 V dc power supply with a 5 wire, solid state relay output, with wire selectable dynamic blanking function. The test input in the SGT may be used for either disabling or enabling the transmitting power temporarily for test purposes.

The advanced automatic signal-tracking (AST) feature ensures that no onsite set up or adjustments are required. The signal level of each individual channel is adjusted automatically, which compensates for

misalignment and contamination during operation. Transmitter and receiver detectors are optically synchronised.

The SG 14 series features the Dynamic Sequential Blanking Function which allows the detectors to be positioned in the guide tracks of an industrial door, where the door travels directly in front of the protection area, interrupting the beams sequentially from top to bottom. The special feature ensures that the system can distinguish between the closing door and an object by ignoring the beams that are obstructed by the moving door whilst leaving the below remaining beams active to detect an object in the protection area.

Both the transmitter and receiver detectors are protected against reverse polarity of power supplies, control input and output signals. The output is also protected against short circuit and inductive loads.

Technical Data			SGT	SGR
Supply voltage	12 – 36 V dc			
Current consumption	Max. 70 mA		50 mA	
Output rating	Solid state	–		200 mA
Short circuit protected	–		Yes	
Reverse polarity protected	Yes			
Light source	Infrared (880 nm)		–	
Number of channels (diodes per detector)	16, 24, 32, 40, 48 or 56			
Number of parallel beams	16, 24, 32, 40, 48 or 56			
Active height	695, 1065, 1430, 1800, 2165 or 2535 mm			
Channel spacing	Between channel 1 and bottom of housing: 25 mm Between other channels: 46 mm			
Response time	–		16/24 chs: 24 ms 32 chs: 30 ms 40 chs: 37 ms 48 chs: 43 ms 56 chs: 49 ms	
Maximum / minimum sequential blanking speed	1,6 m/s / 0,05 m/s			
Minimum size of blanking object	55 mm			
Power on indicator	Green LED			
Output indicator	–		Yellow LED	
System status indicator	–		Red LED	
Time-out function	–			
Housing dimensions (w x d)	Slim Line A	10 x 28 mm		
	Leading Edge B	37,5 x 13 mm		
	Slim Line C	12 x 30 mm		
Housing material	Profile	Aluminium (black anodised)		
	Lens cover	Polycarbonate		
Connection	5 m fixed cable or 5 pin, M12 plug			
Cable, PVC Ø 4,9 mm	3 x 0,20 mm ²		5 x 0,20 mm ²	

Environmental Data

Light immunity @ 5° incidence		> 100 000 lux
Temperature, operation		-20 to +65 °C
Temperature, storage		-40 to +80 °C
Sealing class	A/B housing	IP 54
	C housing	IP 67
Approvals		CE

Available Types

Slim Line A									
Transmitter Detector	Housing Length	Active Height	Number of Channels	Beam Spacing	Connection		5 m cable	0.5 m cable with 5 pin, M12 plug	Range
					Output		Order reference		
	850 mm	695 mm	16	46 mm	-	-	SGT 14-085-016-A1-A-01-5	SGT 14-085-016-A1-A-01-0.5-J5	10 m
	1250 mm	1065 mm	24				SGT 14-125-024-A1-A-01-5	SGT 14-125-024-A1-A-01-0.5-J5	
	1600 mm	1430 mm	32				SGT 14-160-032-A1-A-01-5	SGT 14-160-032-A1-A-01-0.5-J5	
	2000 mm	1800 mm	40				SGT 14-200-040-A1-A-01-5	SGT 14-200-040-A1-A-01-0.5-J5	
	2400 mm	2165 mm	48				SGT 14-240-048-A1-A-01-5	SGT 14-240-048-A1-A-01-0.5-J5	
	2800 mm	2535 mm	56				SGT 14-280-056-A1-A-01-5	SGT 14-280-056-A1-A-01-0.5-J5	

Receiver Detector	Housing Length	Active Height	Number of Channels	Beam Spacing	Solid State Relay	Connection		5 m cable	0.5 m cable with 5 pin, M12 plug	Range
						Output		Order reference		
	850 mm	695 mm	16	46 mm	Solid State Relay	NO		SGR 14-085-016-A1-A-08-5	SGR 14-085-016-A1-A-08-0.5-J5	1-10 m
						NC		SGR 14-085-016-A1-A-09-5	SGR 14-085-016-A1-A-09-0.5-J5	
	1250 mm	1065 mm	24			NO		SGR 14-125-024-A1-A-08-5	SGR 14-125-024-A1-A-08-0.5-J5	
						NC		SGR 14-125-024-A1-A-09-5	SGR 14-125-024-A1-A-09-0.5-J5	
	1600 mm	1430 mm	32			NO		SGR 14-160-032-A1-A-08-5	SGR 14-160-032-A1-A-08-0.5-J5	
						NC		SGR 14-160-032-A1-A-09-5	SGR 14-160-032-A1-A-09-0.5-J5	
	2000 mm	1800 mm	40			NO		SGR 14-200-040-A1-A-08-5	SGR 14-200-040-A1-A-08-0.5-J5	
						NC		SGR 14-200-040-A1-A-09-5	SGR 14-200-040-A1-A-09-0.5-J5	
	2400 mm	2165 mm	48			NO		SGR 14-240-048-A1-A-08-5	SGR 14-240-048-A1-A-08-0.5-J5	
						NC		SGR 14-240-048-A1-A-09-5	SGR 14-240-048-A1-A-09-0.5-J5	
	2800 mm	2535 mm	56			NO		SGR 14-280-056-A1-A-08-5	SGR 14-280-056-A1-A-08-0.5-J5	
						NC		SGR 14-280-056-A1-A-09-5	SGR 14-280-056-A1-A-09-0.5-J5	

Leading Edge B

Transmitter Detector	Housing Length	Active Height	Number of Channels	Beam Spacing	Connection		5 m cable	0.5 m cable with 5 pin, M12 plug	Range
					Output		Order reference		
	850 mm	695 mm	16	46 mm	-	-	SGT 14-085-016-A1-B-01-5	SGT 14-085-016-A1-B-01-0.5-J5	7,5 m
	1250 mm	1065 mm	24				SGT 14-125-024-A1-B-01-5	SGT 14-125-024-A1-B-01-0.5-J5	
	1600 mm	1430 mm	32				SGT 14-160-032-A1-B-01-5	SGT 14-160-032-A1-B-01-0.5-J5	
	2000 mm	1800 mm	40				SGT 14-200-040-A1-B-01-5	SGT 14-200-040-A1-B-01-0.5-J5	
	2400 mm	2165 mm	48				SGT 14-240-048-A1-B-01-5	SGT 14-240-048-A1-B-01-0.5-J5	
	2800 mm	2535 mm	56				SGT 14-280-056-A1-B-01-5	SGT 14-280-056-A1-B-01-0.5-J5	

Receiver Detector	Housing Length	Active Height	Number of Channels	Beam Spacing	Solid State Relay	Connection		5 m cable	0.5 m cable with 5 pin, M12 plug	Range
						Output		Order reference		
	850 mm	695 mm	16	46 mm	Solid State Relay	NO		SGR 14-085-016-A1-B-08-5	SGR 14-085-016-A1-B-08-0.5-J5	1-7,5 m
						NC		SGR 14-085-016-A1-B-09-5	SGR 14-085-016-A1-B-09-0.5-J5	
	1250 mm	1065 mm	24			NO		SGR 14-125-024-A1-B-08-5	SGR 14-125-024-A1-B-08-0.5-J5	
						NC		SGR 14-125-024-A1-B-09-5	SGR 14-125-024-A1-B-09-0.5-J5	
	1600 mm	1430 mm	32			NO		SGR 14-160-032-A1-B-08-5	SGR 14-160-032-A1-B-08-0.5-J5	
						NC		SGR 14-160-032-A1-B-09-5	SGR 14-160-032-A1-B-09-0.5-J5	
	2000 mm	1800 mm	40			NO		SGR 14-200-040-A1-B-08-5	SGR 14-200-040-A1-B-08-0.5-J5	
						NC		SGR 14-200-040-A1-B-09-5	SGR 14-200-040-A1-B-09-0.5-J5	
	2400 mm	2165 mm	48			NO		SGR 14-240-048-A1-B-08-5	SGR 14-240-048-A1-B-08-0.5-J5	
						NC		SGR 14-240-048-A1-B-09-5	SGR 14-240-048-A1-B-09-0.5-J5	
	2800 mm	2535 mm	56			NO		SGR 14-280-056-A1-B-08-5	SGR 14-280-056-A1-B-08-0.5-J5	
						NC		SGR 14-280-056-A1-B-09-5	SGR 14-280-056-A1-B-09-0.5-J5	

Available Types

Water-Resistant Slim Line C

Transmitter Detector	Housing Length	Active Height	Number of Channels	Beam Spacing	Connection		5 m cable	0.5 m cable with 5 pin, M12 plug	Range
					Output		Order reference		
	850 mm	695 mm	16	46 mm	-	-	SGT 14-085-016-A1-C-01-5	SGT 14-085-016-A1-C-01-0.5-J5	10 m
	1250 mm	1065 mm	24				SGT 14-125-024-A1-C-01-5	SGT 14-125-024-A1-C-01-0.5-J5	
	1600 mm	1430 mm	32				SGT 14-160-032-A1-C-01-5	SGT 14-160-032-A1-C-01-0.5-J5	
	2000 mm	1800 mm	40				SGT 14-200-040-A1-C-01-5	SGT 14-200-040-A1-C-01-0.5-J5	
	2400 mm	2165 mm	48				SGT 14-240-048-A1-C-01-5	SGT 14-240-048-A1-C-01-0.5-J5	
	2800 mm	2535 mm	56				SGT 14-280-056-A1-C-01-5	SGT 14-280-056-A1-C-01-0.5-J5	

Receiver Detector	Housing Length	Active Height	Number of Channels	Beam Spacing	Solid State Relay	Connection	5 m cable	0.5 m cable with 5 pin, M12 plug	Range
						NO	SGR 14-085-016-A1-C-08-5	SGR 14-085-016-A1-C-08-0.5-J5	
						NC	SGR 14-085-016-A1-C-09-5	SGR 14-085-016-A1-C-09-0.5-J5	
						NO	SGR 14-125-024-A1-C-08-5	SGR 14-125-024-A1-C-08-0.5-J5	
						NC	SGR 14-125-024-A1-C-09-5	SGR 14-125-024-A1-C-09-0.5-J5	
						NO	SGR 14-160-032-A1-C-08-5	SGR 14-160-032-A1-C-08-0.5-J5	
						NC	SGR 14-160-032-A1-C-09-5	SGR 14-160-032-A1-C-09-0.5-J5	
						NO	SGR 14-200-040-A1-C-08-5	SGR 14-200-040-A1-C-08-0.5-J5	
						NC	SGR 14-200-040-A1-C-09-5	SGR 14-200-040-A1-C-09-0.5-J5	
						NO	SGR 14-240-048-A1-C-08-5	SGR 14-240-048-A1-C-08-0.5-J5	
NC	SGR 14-240-048-A1-C-09-5	SGR 14-240-048-A1-C-09-0.5-J5							
NO	SGR 14-280-056-A1-C-08-5	SGR 14-280-056-A1-C-08-0.5-J5							
NC	SGR 14-280-056-A1-C-09-5	SGR 14-280-056-A1-C-09-0.5-J5							

Note: The transmitter SGT and receiver SGR set must have the same number of channels.

Connections

	Cable	M12 Plug/Cable
Supply +	Brown	Pin 1/Brown
Supply -	Blue	Pin 3/Blue
SGT test input	Black	Pin 4/Black
SGR output	Black	Pin 4/Black
SGR output	Black	Pin 5/Grey
SGR blanking function control	White	Pin 2/White

5 pin, M12

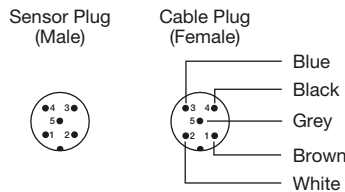

Refer to page 155 for extension cables

Wiring Diagrams

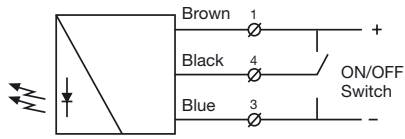

SGT 14
Connect black test input wire to + or - to disable SGT

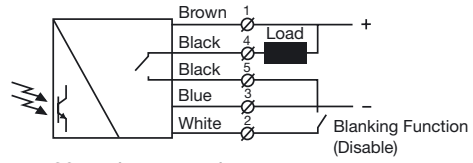

SGR 14 (load as NPN)

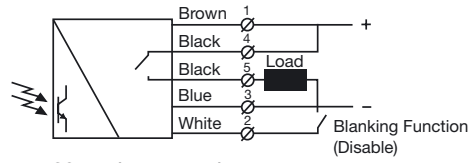

SGR 14 (load as PNP)

Dimensions and Descriptions

Slim Line A

Details

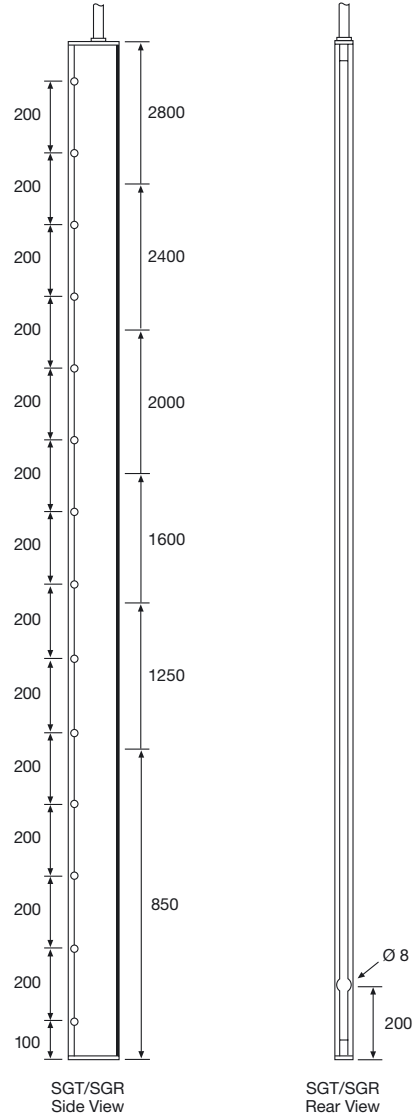
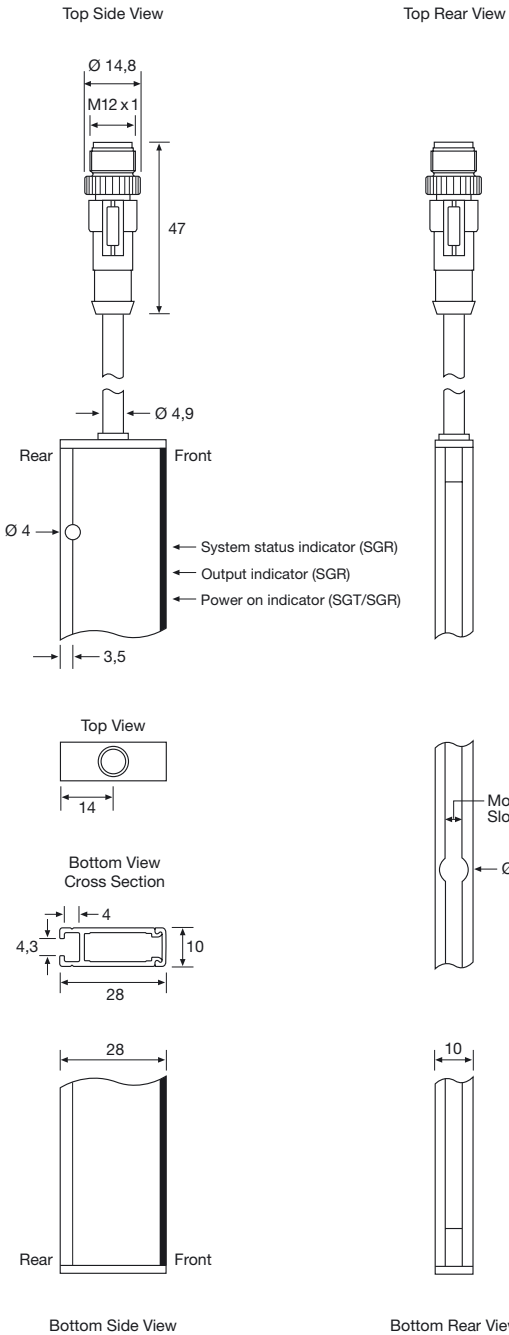

Note: Drawing shows model with M12 plug

(Units in mm)

Dimensions and Descriptions

Leading Edge B

Details

SGT
Top Front View

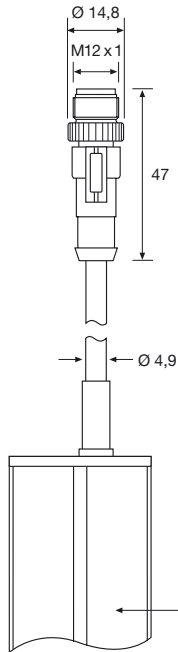

Top View

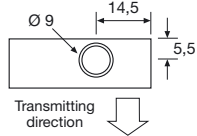

Bottom View
Cross Section

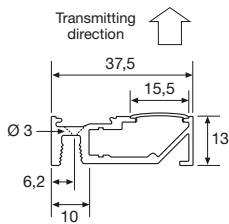

Bottom Front View

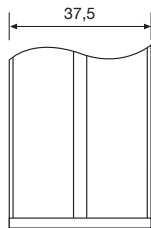

SGR
Top Front View

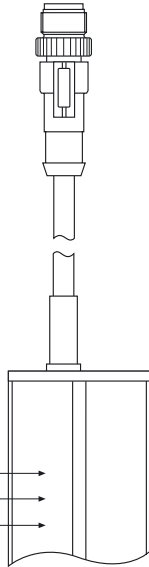

Top View

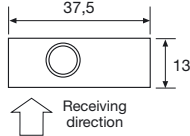

Bottom View
Cross Section

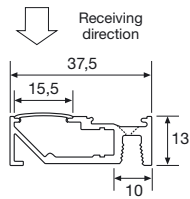

Bottom Front View

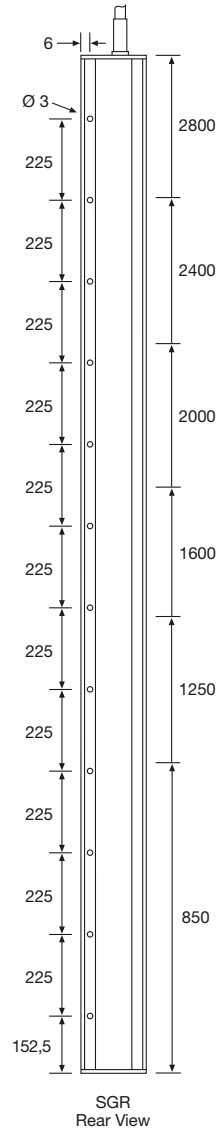
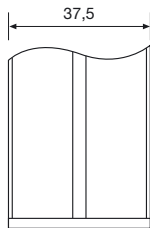

SGR
Rear View

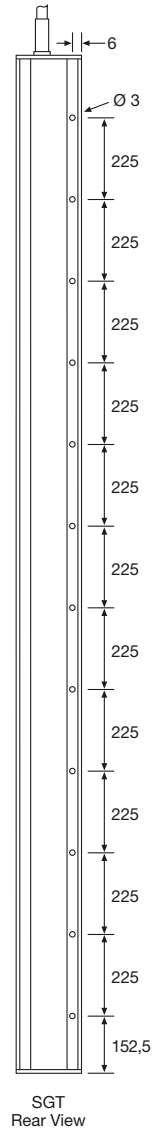

SGT
Rear View

Note: Drawing shows model with M12 plug

(Units in mm)

Dimensions and Descriptions

Water-Resistant Slim Line C

Details

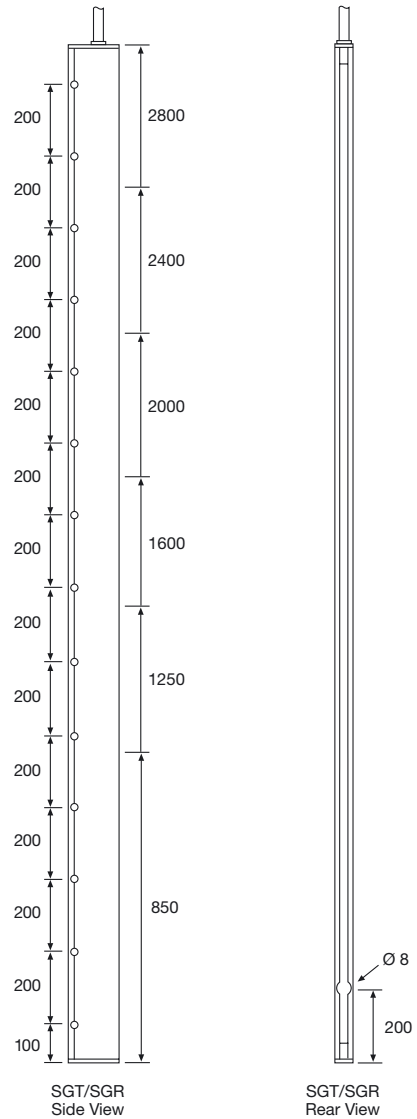
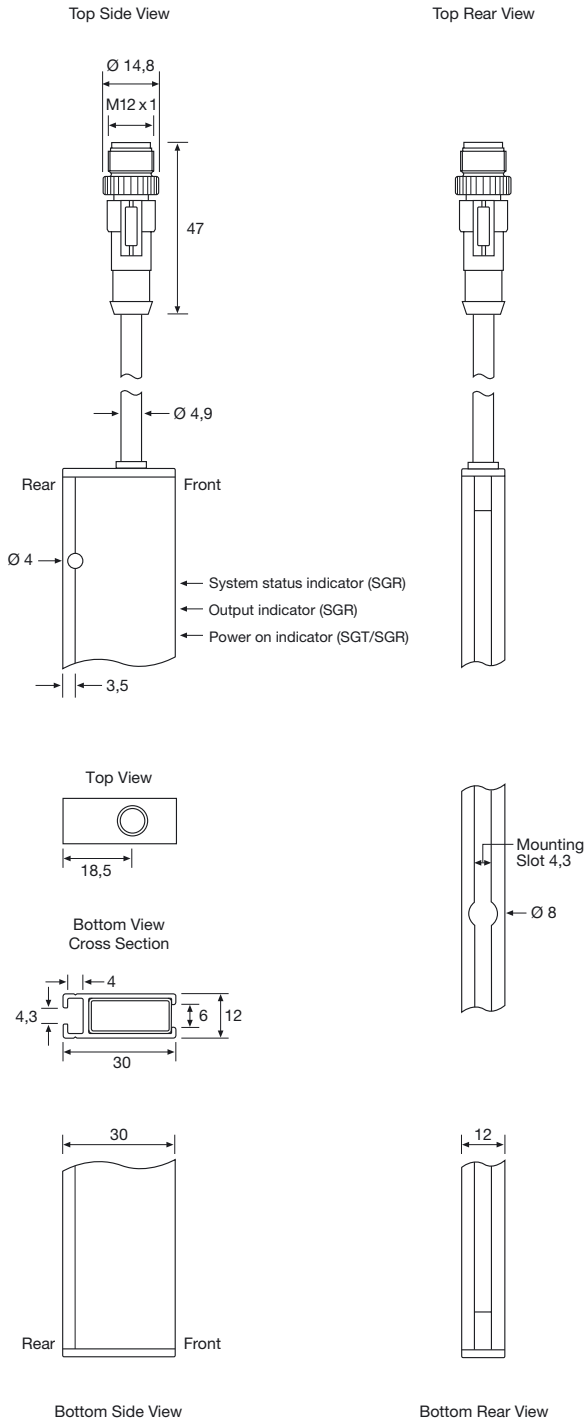

Note: Drawing shows model with M12 plug

(Units in mm)

Beam Patterns

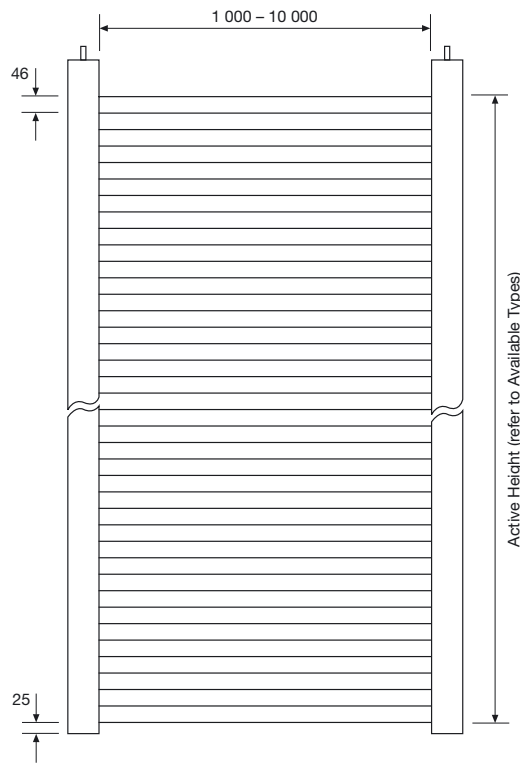

46 mm channel spacing

(Units in mm)

Sensing Characteristics

Parallel Displacement

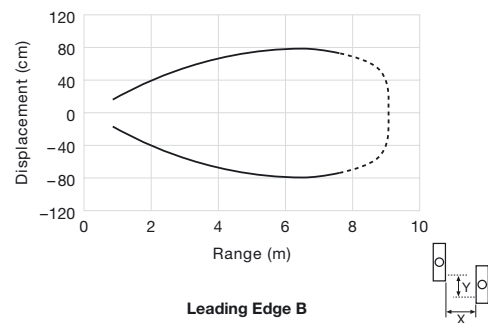
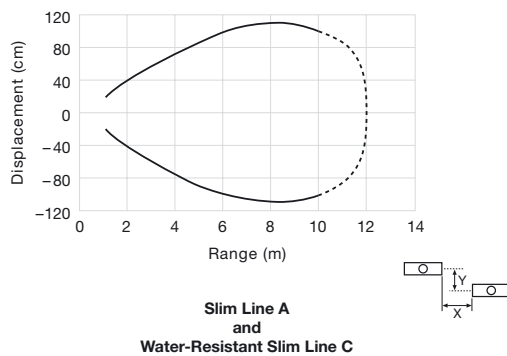

Telco reserves the right to change specifications without notice.